

# Stylus

 *Studio Office*

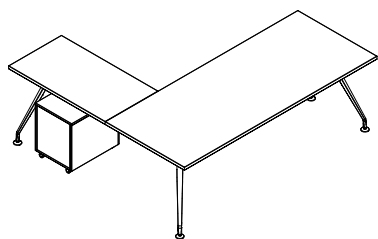

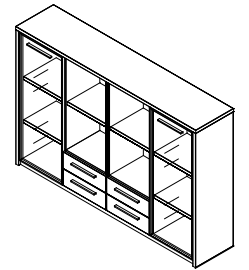

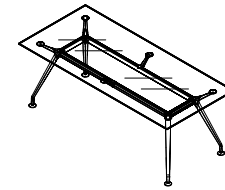
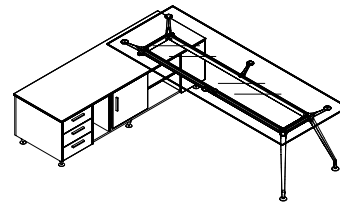



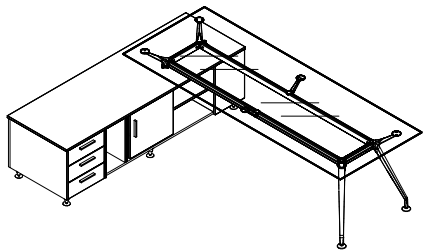

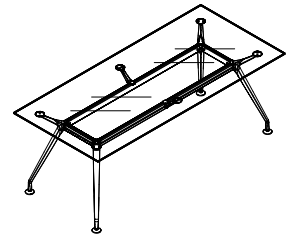



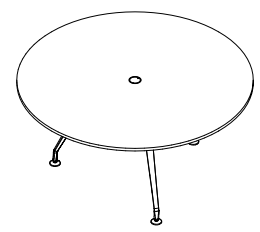
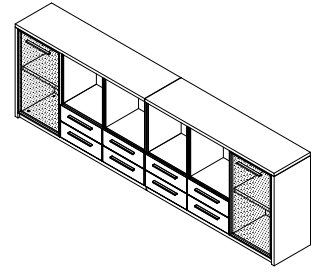
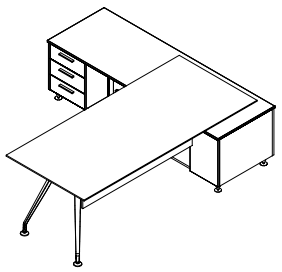

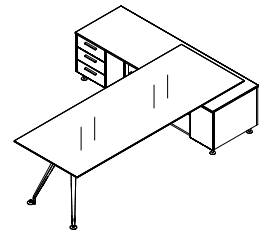
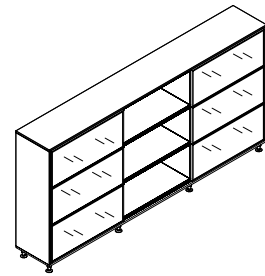
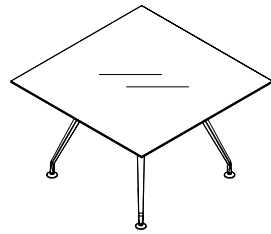



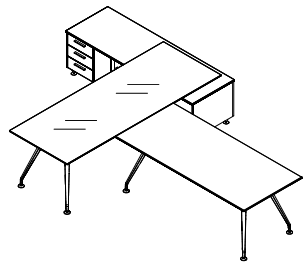
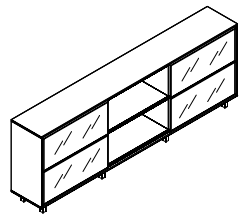



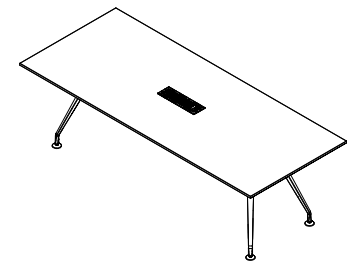
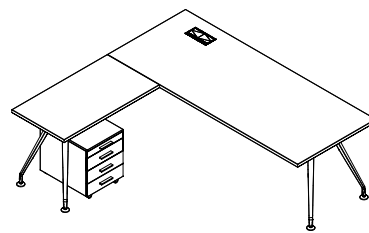
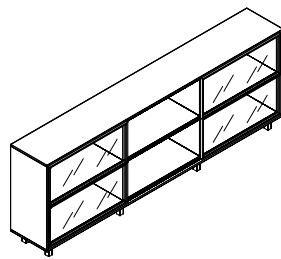

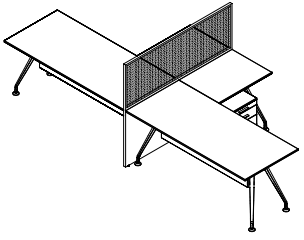
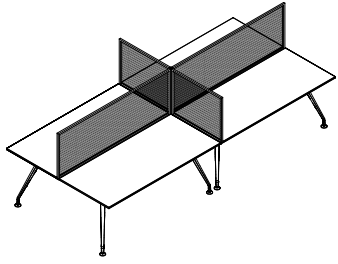
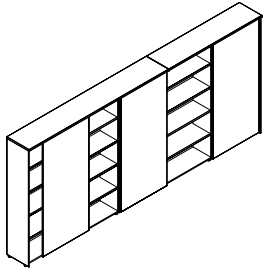



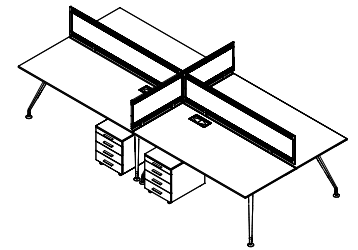
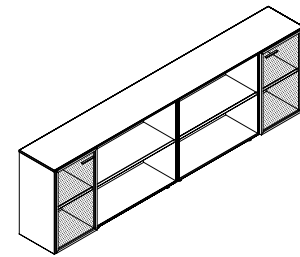



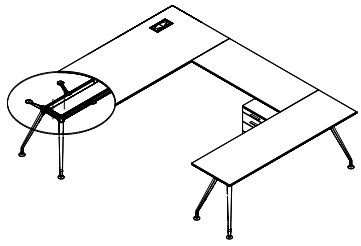

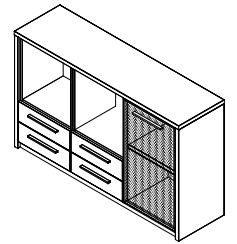
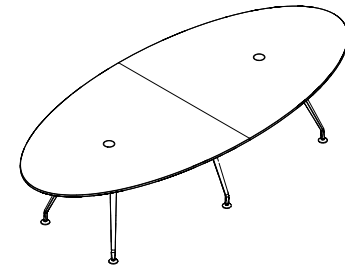



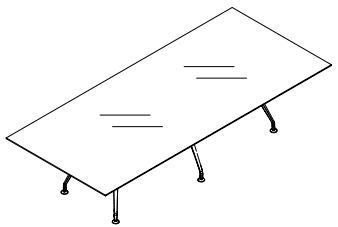



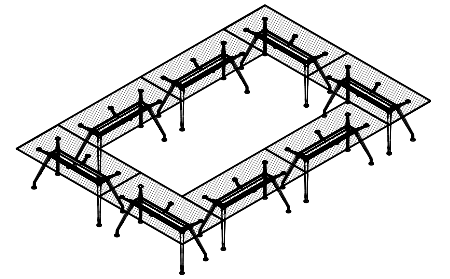

### DESK LEG

Made of cast aluminum polished shined to perfection, each leg independently supports the desk top at each of the desk's four corners. The foot-glide at the bottom part of each leg, is fitted with leveling adjusters for possible floor abnormalities. Supplied knock-down, packed in triple-layer cardboard and complete with all the hardware for fixing the top on-site.

### HORIZONTAL SUPPORT BEAM

They come in two pairs of transversal rods (front, back, left and right), forming a rectangular structural frame at about 8cm below the desk top. Thus, the desk top is basically suspended giving the feeling of floating. Each leg is fixed at each corner of the rectangular shape of the beams. Each beam is painted in black colour.

### DESK TOP BRACKETS

Each desk top rests onto special brackets. The four corner supports are basically an integral part of the leg itself. The intermediate brackets are supported on the transversal beams which the desk top rests by gravity on special small foam cushion.

### DESKTOPS and EXTENSIONS

All tops are made of 18mm-thick melamine faced chipboard and edged with 2mm-thick matching PVC and alternatively with 10mm-thick glass top. They come in a variety of lengths and widths. The glass top is available is clear transparent or in frosted finish.

### MODESTY PANELS FOR DESKS

The modesty panels are available as optional to compliment privacy on the STYLUS desk collection. They are made of 18mm-thick melamine-faced chipboard in matching colour with the desk top with PVC. The fixing brackets of the modesty panel are supported on the front transverse beam.

### STORAGE UNITS

- The carcass structure is made of 18 mm thick particleboards faced with wax-finish melamine, available in the standard melamine colour card.
- Four cast aluminum polished of shining texture foot height-adjusters are available for each cabinet to compensate for possible floor abnormalities.
- The doors are made of 18 mm thick particleboards faced with wax-finish melamine and are available in the standard melamine colour card. They are edged with 2 mm-thick PVC edgebanding material to match the surface.
- All shelves are adjustable ones at increments of 32mm and carry a thickness of 30mm.
- The glass doors are available with clear, frosted or tinted tempered glass finish and come

in 3 versions: the first version comes without a frame. The second version comes with a slim aluminum-look frame in silver or chrome finish while the third one comes with a melamine wood-frame available in the standard melamine colour card to match the carcass panels surface.

- All doors come as standard without a lock but a 2-key lock is available upon request.
- All doors can be optionally available with soft closing hinges
- All locks come with interchangeable cylinders and master key as an optional extra
- Door handles are available in black or silver or transparent finish

### DRAWER UNITS

- The carcass structure is made of 18 mm thick particleboards faced with wax-finish melamine, available in the standard melamine colour card.
- The carcass panels are edged with 0,8mm-thick PVC edgebanding material to match the surface.
- The drawer fronts are made of 18 mm thick particleboards faced with wax-finish melamine and are available in the standard melamine colour card. They are edged with 2mm-thick PVC edgebanding material to match the surface.
- The wood drawers feature a central lock with interchangeable cylinder with 2 keys. A master-key is available upon request at an optional extra
- The runners are made of metal with nylon bearings complete with mechanical extraction stops and self-closing mechanism.
- The drawer units have black nylon double-action heavy-duty castors.

### KD FITTINGS

All connections for all the above furniture are carried through a 4-part metal KD fitting. Metal inserts are permanently inserted in the core of the particleboard enabling easier and unlimited easier and unlimited disassembly and re-assembly.

FINISHES

GLASS



BLACK



GREEN



RED



WHITE

WOOD



3D DARK



3D GREY OAK



3D METALLIC

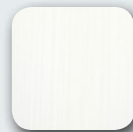

3D SNOW  
White



3D WALNUT  
NAPA



BEECH NWT



JOY WALNUT



BLACK



CHERRY S



CHERRY T



DARK HD

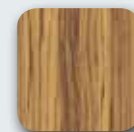

ELIA 3D

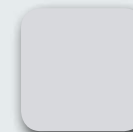

GREY SAND

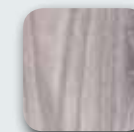

3D LIMASSOL  
OAC



RIGE  
CHOCOLATE



RIGE ICE



RIGE STONE



3D ASSIA



SILVER



WALNUT  
AMATHUS



WALNUT  
NICOSIE



WALNUT



WENGE



WHITE OAK



WHITE



OAK KERYNIA



3D SAWN WOOD  
KAMBOS



3D PETRA  
ROMIOU



STYLUS DIMENSIONS

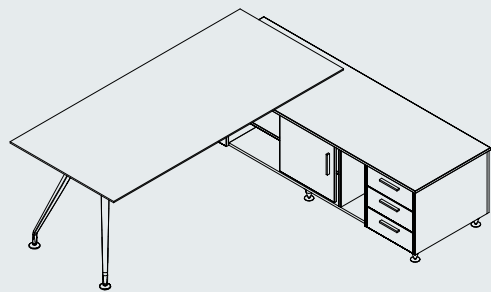

200x200x75  
220x200x75  
240x200x75

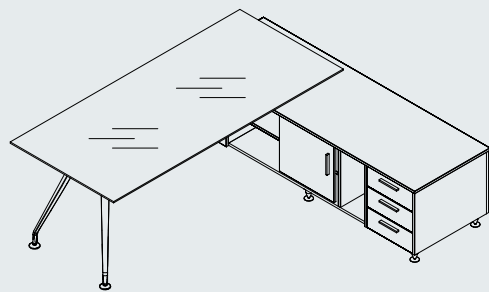

200x200x75  
220x200x75  
240x200x75

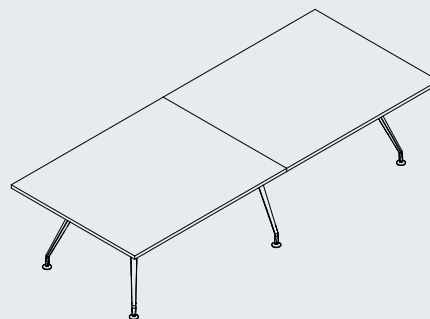

280x120x75 340x120x75  
300x120x75 360x120x75  
320x120x75

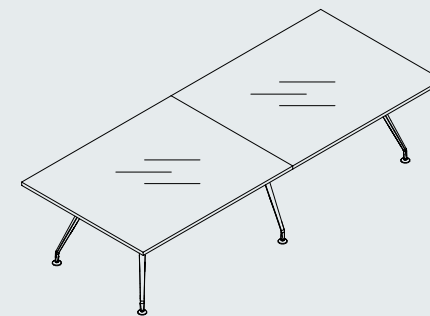

280x120x75 340x120x75  
300x120x75 360x120x75  
320x120x75

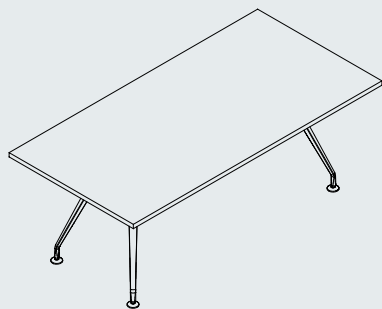

180x80x75 200x90x75  
200x80x75 220x90x75  
180x90x75

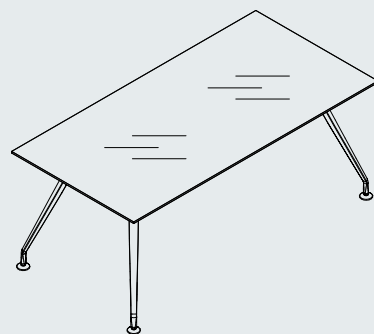

180x80x75 200x90x75  
200x80x75 220x90x75  
180x90x75

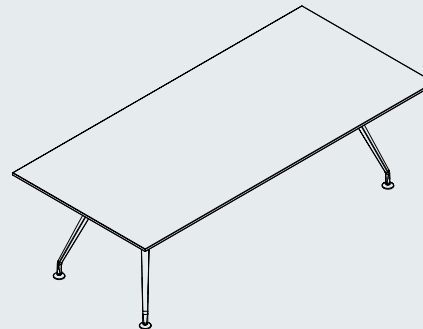

200x100x75 250x100x75  
220x100x75  
240x100x75

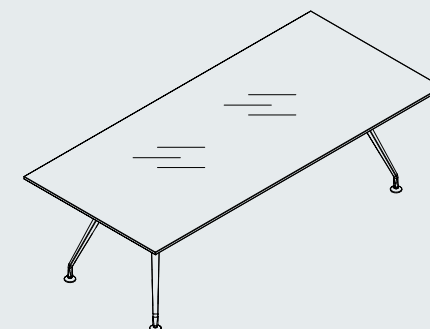

200x100x75 250x100x75  
220x100x75  
240x100x75

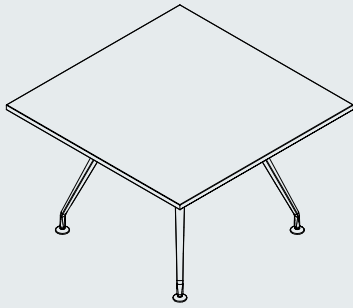

120x120x75 150x150x75  
130x130x75 160x160x75  
140x140x75

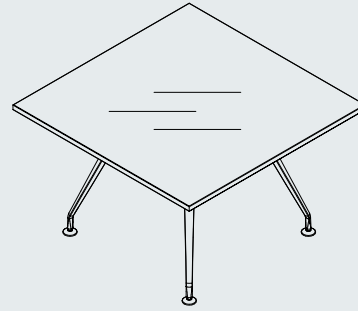

120x120x75 150x150x75  
130x130x75 160x160x75  
140x140x75

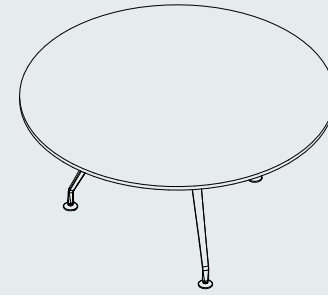

120Φ 150Φ  
130Φ  
140Φ

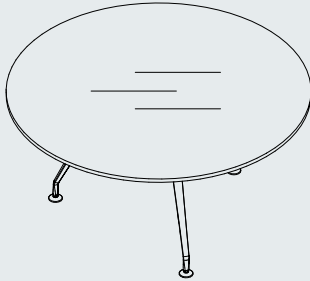

120Φ 150Φ  
130Φ  
140Φ

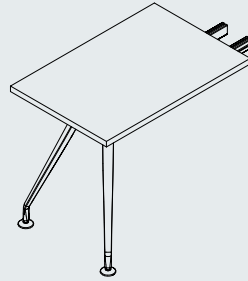

80x60x75 110x60x75  
90x60x75 120x60x75  
100x60x75 130x60x75

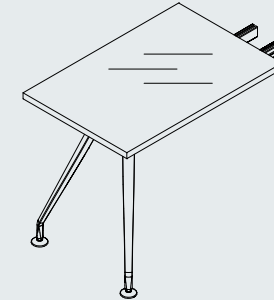

80x60x75 110x60x75  
90x60x75 120x60x75  
100x60x75 130x60x75

## Takis Charalambous & Co Ltd.

### Head Office & Main Showroom:

19 Vyzantiou Str., 2064 Nicosia-Cyprus,  
Tel: +357 22874444, Fax: +357 22495460,  
Email: sales@takis.com

### Factory & Stores:

Ergates Industrial Area, 2643 Nicosia-Cyprus,  
Tel: +357 22621419, Fax: +357 22623007,  
Email: operations@takis.com

### Mailing / Web:

P.O.Box 28739, 2082 Nicosia-Cyprus,  
<http://www.takis.com>

