

# Lamda & Lamda Wood

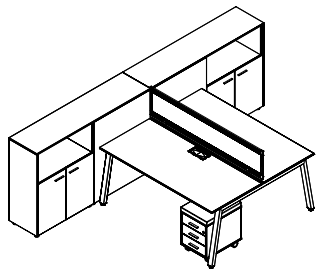

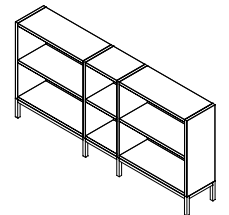

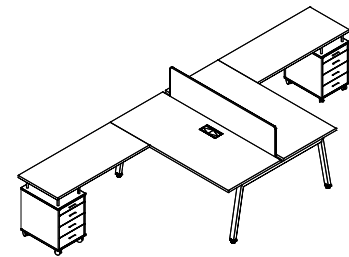

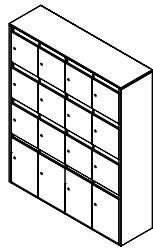
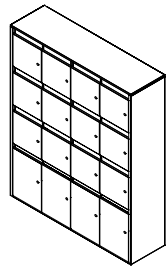
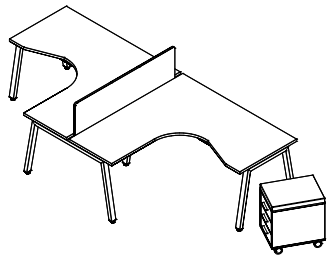
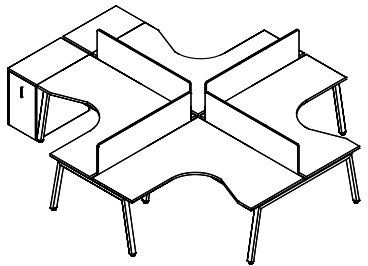

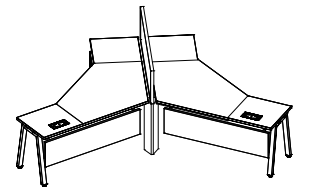
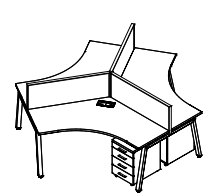

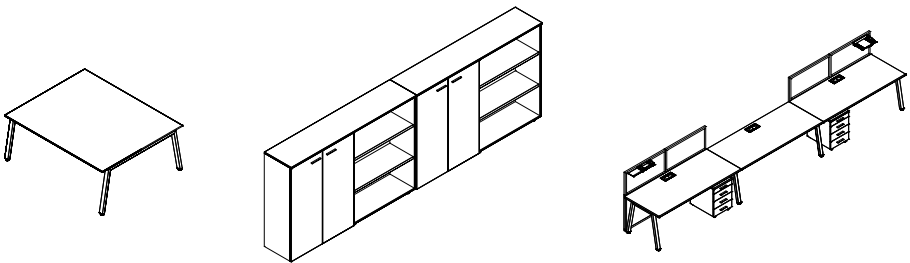

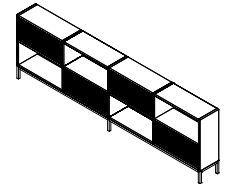
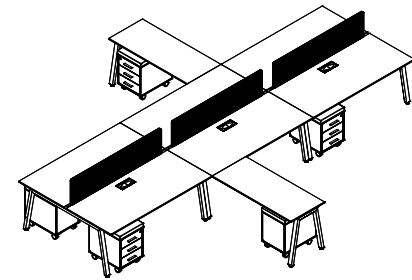
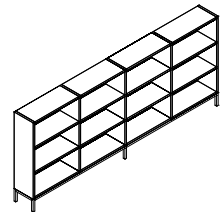

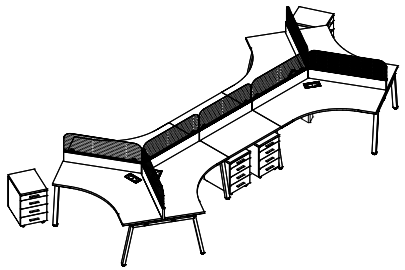
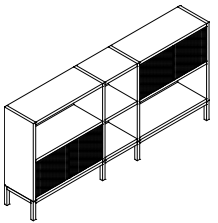



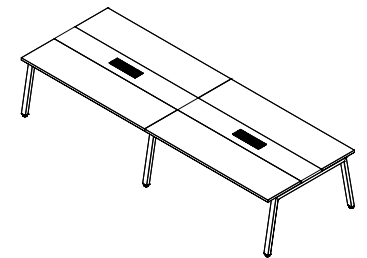
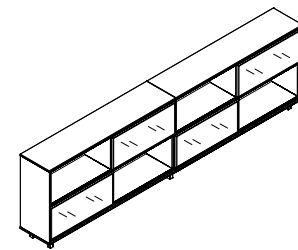

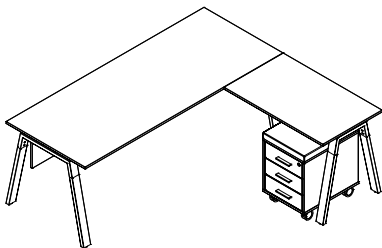
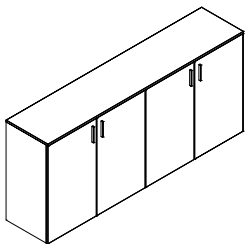
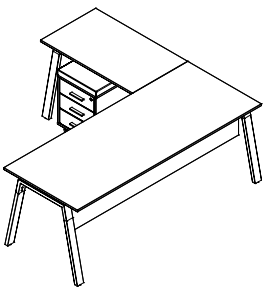

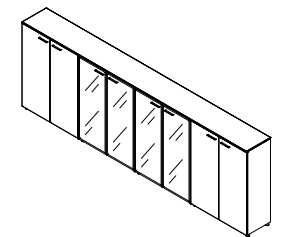
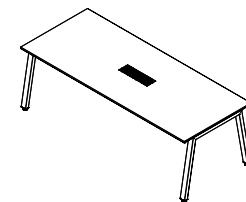
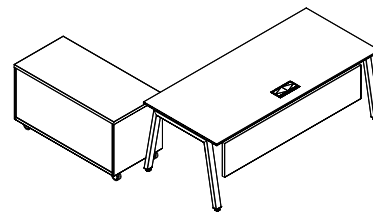

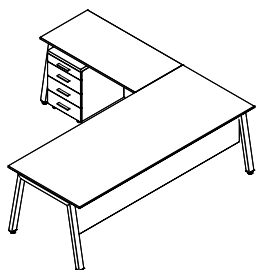
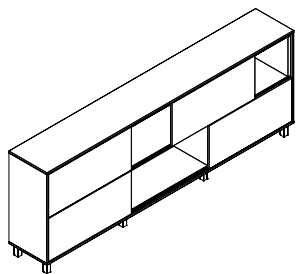

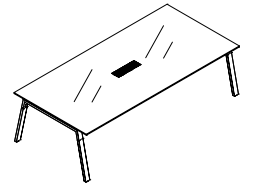
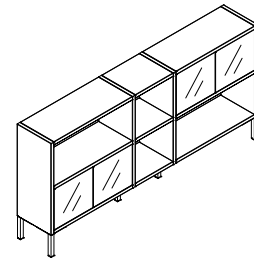

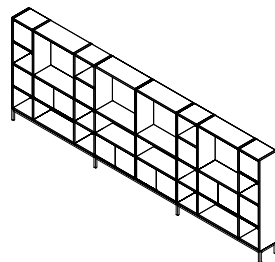
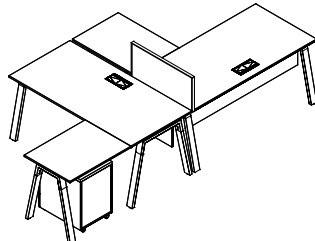
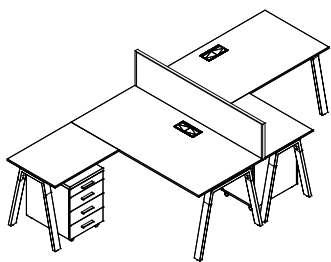
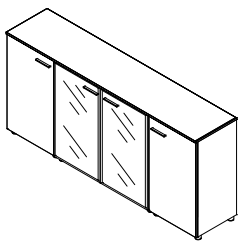
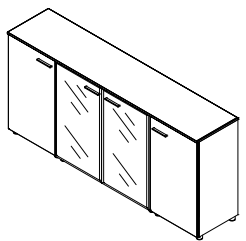

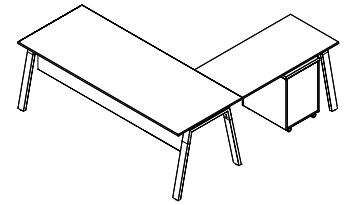
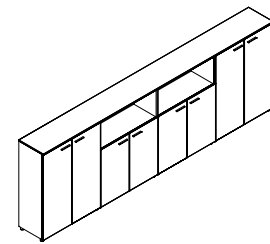

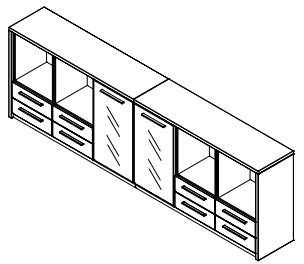
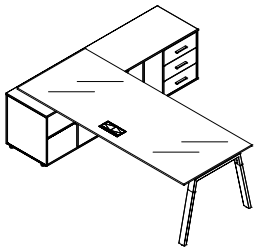
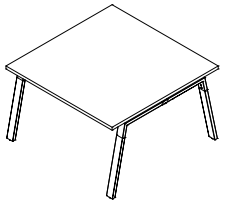



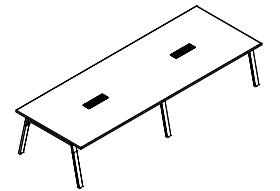
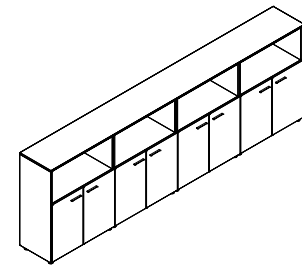

**DESK LEG**

Metal frame support on 4 inclined legs. The legs are made of tubular metal profiles of rectangular cross-sectional, folded, welded, and coated in epoxy powder. Alternatively, in LAMDA WOOD desk, the legs are made of partly solid wood of matching design shape to the metal. On the horizontal element of each leg, there are special "C" shaped brackets with holes for the tubular beams while, in the lower part, wooden elements are inserted and screwed to complete the leg. Foot is fitted with leveling feet for possible floor level abnormalities. Available in two versions to be used for tops of 80 and 60 cm in depth. Supplied knock-down, packed in triple-layer cardboard and complete with screws for fixing to the tops.

**HORIZONTAL SUPPORT BEAM**

They come in pairs for each individual desk top and they are made of square-sectioned tubular steel, painted in black, white and silver colors. They are supplied complete with plastic fixtures supported to the C-shape brackets of the legs. The beams come in lengths varying from 80cm to 200cm and can be used for both single and bench desks. Optional cable tray is available being supported on the support beams.

**DESKTOPS and EXTENSIONS**

These are divided into two categories: with shaped tops and with edged tops. Made of 18mm-thick melamine faced chipboard and edged with 2mm-thick matching PVC/ABS.

**MODESTY PANELS FOR DESKS**

Available in wood or in metal. The wooden one is made of 18 mm thick melamine-faced chipboard in matching colour with the desk top with PVC/ABS edging.

The metal one is available in perforated or solid form.

**STORAGE UNITS**

- The carcass structure is made of 18 mm thick particleboards faced with wax-finish melamine, available in the standard melamine colour card.
- Four foot height-adjusters are available for each cabinet in order to compensate for possible floor abnormalities.
- The doors are made of 18 mm thick particleboards faced with wax-finish melamine and are available in the standard melamine colour card. They are edged with 2,1 mm-thick PVC/ABS edgebanding material to match the surface.
- All shelves are adjustable ones at increments of 32mm and carry a thickness of 30mm.

- The glass doors are available with clear, coated, frosted or tinted tempered glass finish and come in 3 versions: the first version comes without a frame. The second version comes with a slim aluminum-look frame in silver or chrome finish while the third one comes with a melamine wood-frame available in the standard melamine colour card to match the carcass panels surface.
- All doors come as standard without a lock but a 2-key lock is available upon request.
- All doors can be optionally available with soft closing hinges.
- All locks come with interchangeable cylinders and master key as an optional extra.
- Door handles are available in black or silver or transparent finish.

**DRAWER UNITS**

- The carcass structure is made of 18 mm thick particleboards faced with wax-finish melamine, available in the standard melamine colour card.
- The carcass panels are edged with 0,8mm-thick PVC/ABS edgebanding material to match the surface.
- The drawer fronts are made of 18 mm thick particleboards faced with wax-finish melamine and are available in the standard melamine colour card. They are edged with 2mm-thick PVC/ABS edgebanding material to match the surface.
- The wood drawers feature a central lock with 2 keys. A master-key is available upon request as an optional extra.
- The runners are made of metal with nylon bearings complete with mechanical extraction stops and self-closing mechanism.
- The drawer units have black nylon double-action heavy-duty castors.

**KD FITTINGS**

All connections are carried through a 4-part metal KD fitting. Metal inserts are permanently inserted in the core of the particleboard enabling easier and unlimited easier and unlimited disassembly and re-assembly.

WOOD



3D DARK



3D GREY OAK



3D METALLIC

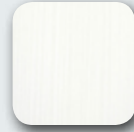

3D SNOW  
White



3D WALNUT  
NAPA

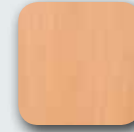

BEECH NWT



JOY WALNUT



BLACK



CHERRY S



CHERRY T



DARK HD

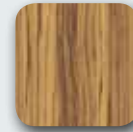

ELIA 3D



GREY SAND



3D LIMASSOL  
OAC



ARTIC OAK



RIGE ICE



RIGE STONE



3D ASSIA



SILVER



WALNUT  
AMATHUS



WALNUT  
NICOSIE



WALNUT



WENGE



WHITE OAK

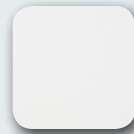

WHITE



OAK KERYNIA



3D SAWN WOOD  
KAMBOS



3D PETRA  
ROMIOU

# LAMDA & LAMDA WOOD DIMENSIONS

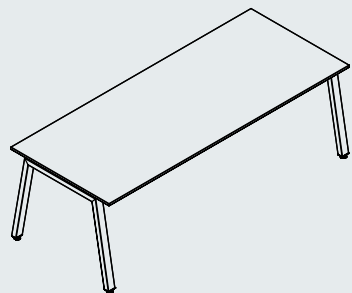

WHITE / BEECH WOOD		SILVER / WHITE	
80x80x74	160x80x74	80x80x76	160x80x76
100x80x74	180x80x74	100x80x76	180x80x76
120x80x74	200x80x74	120x80x76	200x80x76
140x80x74		140x80x76	

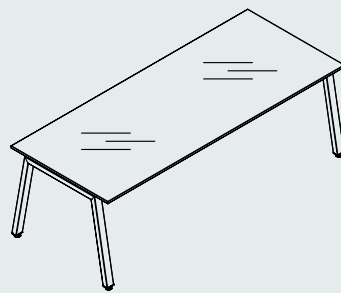

WHITE / BEECH WOOD		SILVER / WHITE	
80x80x74	160x80x74	80x80x76	160x80x76
100x80x74	180x80x74	100x80x76	180x80x76
120x80x74	200x80x74	120x80x76	200x80x76
140x80x74		140x80x76	

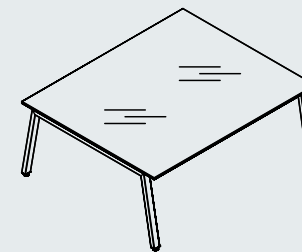

WHITE / BEECH WOOD		SILVER / WHITE	
80x123,5x74	80x163,5x74	80x123,5x76	80x163,5x76
100x123,5x74	100x163,5x74	100x123,5x76	100x163,5x76
120x123,5x74	120x163,5x74	120x123,5x76	120x163,5x76
140x123,5x74	140x163,5x74	140x123,5x76	140x163,5x76
160x123,5x74	160x163,5x74	160x123,5x76	160x163,5x76
180x123,5x74	180x163,5x74	180x123,5x76	180x163,5x76
200x123,5x74	200x163,5x74	200x123,5x76	200x163,5x76

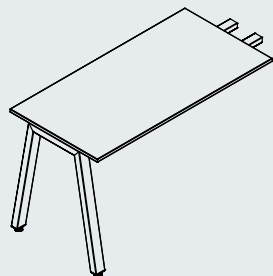

WHITE / BEECH WOOD		SILVER / WHITE	
80x80x74	160x80x74	80x80x76	160x80x76
100x80x74	180x80x74	100x80x76	180x80x76
120x80x74	200x80x74	120x80x76	200x80x76
140x80x74		140x80x76	

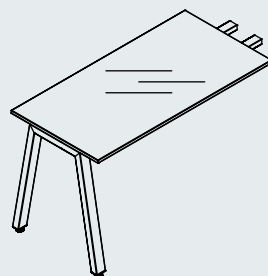

WHITE / BEECH WOOD		SILVER / WHITE	
80x80x74	160x80x74	80x80x76	160x80x76
100x80x74	180x80x74	100x80x76	180x80x76
120x80x74	200x80x74	120x80x76	200x80x76
140x80x74		140x80x76	

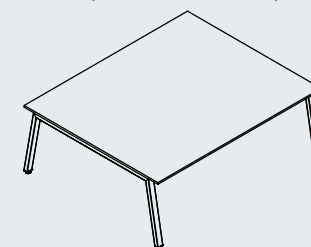

WHITE / BEECH WOOD		SILVER / WHITE	
80x123,5x74	80x163,5x74	80x123,5x76	80x163,5x76
100x123,5x74	100x163,5x74	100x123,5x76	100x163,5x76
120x123,5x74	120x163,5x74	120x123,5x76	120x163,5x76
140x123,5x74	140x163,5x74	140x123,5x76	140x163,5x76
160x123,5x74	160x163,5x74	160x123,5x76	160x163,5x76
180x123,5x74	180x163,5x74	180x123,5x76	180x163,5x76
200x123,5x74	200x163,5x74	200x123,5x76	200x163,5x76

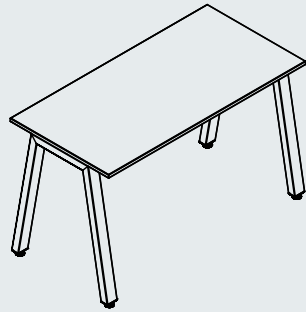

WHITE / BEECH WOOD		SILVER / WHITE	
80x80x74	140x80x74	80x80x76	140x80x76
100x80x74	160x80x74	100x80x76	160x80x76
120x80x74	180x80x74	120x80x76	180x80x76

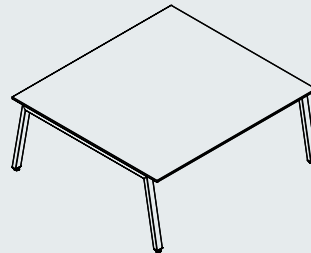

WHITE / BEECH WOOD		SILVER / WHITE	
200x123,5x74		200x123,5x76	
220x123,5x74		220x123,5x76	

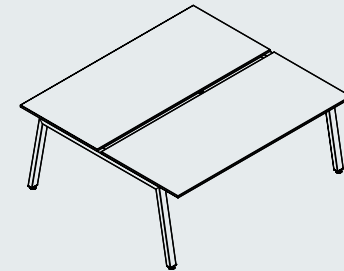

WHITE / BEECH WOOD		SILVER / WHITE	
140x163,5x74	140x163,5x74	140x163,5x76	140x163,5x76
160x163,5x74	160x163,5x74	160x163,5x76	160x163,5x76
180x163,5x74	180x163,5x74	180x163,5x76	180x163,5x76

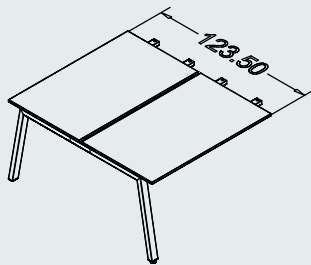

WHITE / BEECH WOOD		SILVER / WHITE	
60x123,5x74		60x123,5x76	
80x123,5x74		80x123,5x76	

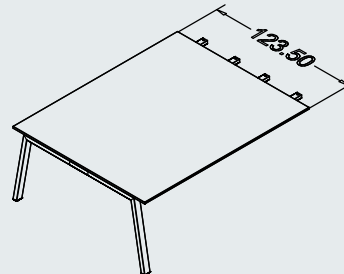

WHITE / BEECH WOOD		SILVER / WHITE	
80x123,5x74	160x123,5x74	80x123,5x76	160x123,5x76
100x123,5x74	180x123,5x74	100x123,5x76	180x123,5x76
120x123,5x74	200x123,5x74	120x123,5x76	200x123,5x76
140x123,5x74		140x123,5x76	

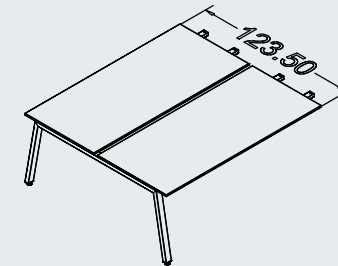

WHITE / BEECH WOOD		SILVER / WHITE	
140x123,5x74		140x123,5x76	
160x123,5x74		160x123,5x76	
180x123,5x74		180x123,5x76	

LAMDA& LAMDA WOOD DIMENSIONS

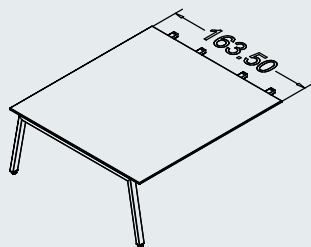

WHITE / BEECH WOOD

80x163,5x74 160x163,5x74  
 100x163,5x74 180x163,5x74  
 120x163,5x74 200x163,5x74  
 140x163,5x74

SILVER / WHITE

80x163,5x76 160x163,5x76  
 100x163,5x76 180x163,5x76  
 120x163,5x76 200x163,5x76  
 140x163,5x76

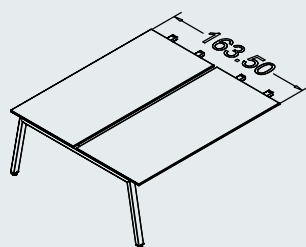

WHITE / BEECH WOOD

140x163,5x74  
 160x163,5x74  
 180x163,5x74

SILVER / WHITE

140x163,5x76  
 160x163,5x76  
 180x163,5x76

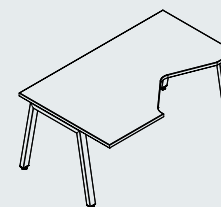

WHITE / BEECH WOOD

160x100x74

SILVER / WHITE

160x100x76

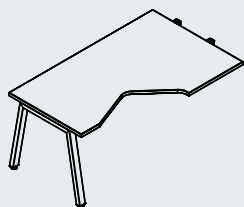

WHITE / BEECH WOOD

323,5X100X74

SILVER / WHITE

323,5X100X76

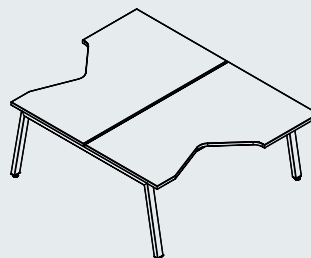

WHITE / BEECH WOOD

203X160X74

SILVER / WHITE

203X160X76

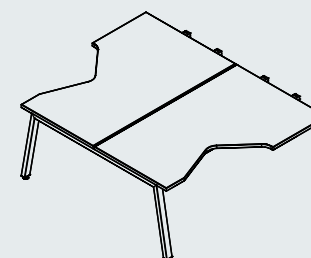

WHITE / BEECH WOOD

203X160X74

SILVER / WHITE

203X160X76

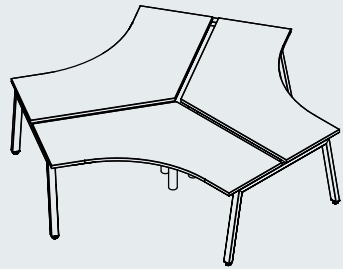

WHITE / BEECH WOOD  
275x235x74

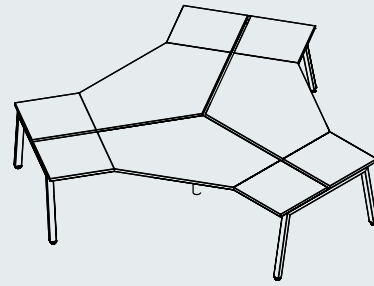

SILVER / WHITE  
275x235x76

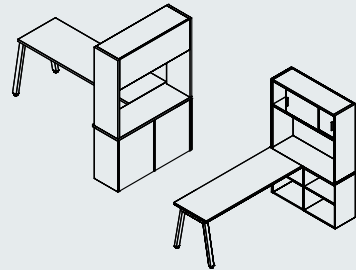
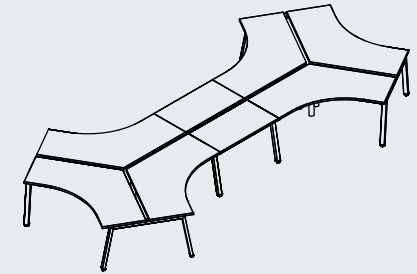
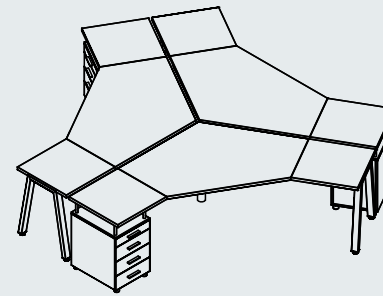

161x120x186    201x120x186  
181x120x186    221x120x186

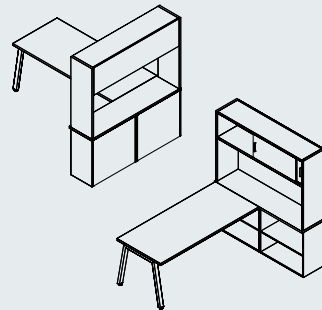

161x160x186    201x160x186  
181x160x186    221x160x186

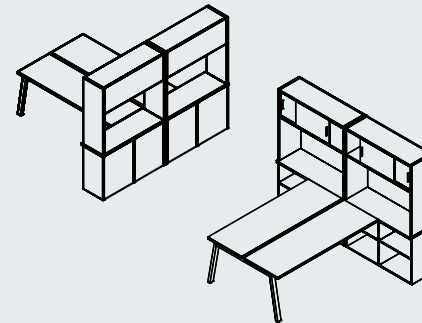

161x240x186    201x240x186  
181x240x186    221x240x186

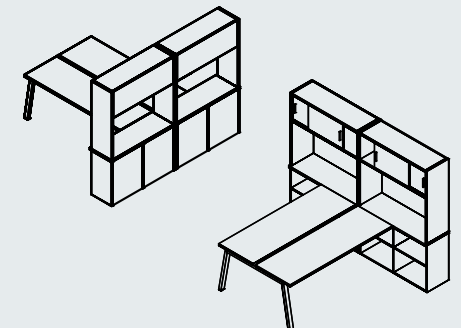

161x320x186    201x320x186  
181x320x186    221x320x186

## Takis Charalambous & Co Ltd.

### Head Office & Main Showroom:

19 Vyzantiou Str., 2064 Nicosia-Cyprus,  
Tel: +357 22874444, Fax: +357 22495460,  
Email: sales@takis.com

### Factory & Stores:

Ergates Industrial Area, 2643 Nicosia-Cyprus,  
Tel: +357 22621419, Fax: +357 22623007,  
Email: operations@takis.com

### Mailing / Web:

P.O.Box 28739, 2082 Nicosia-Cyprus,  
<http://www.takis.com>

