

Fly & Fly Executive

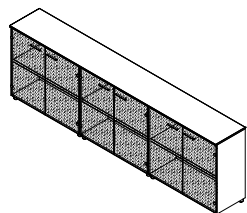

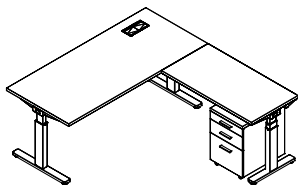

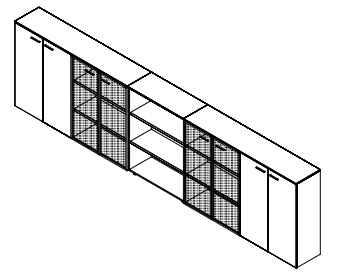

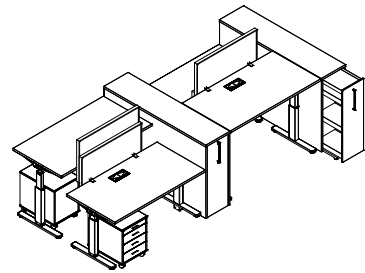
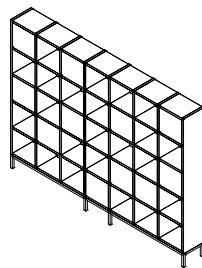
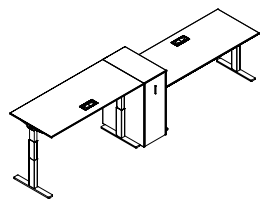

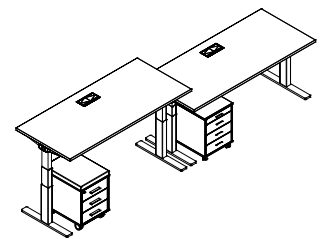

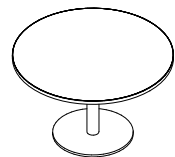
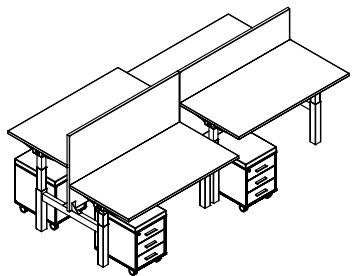

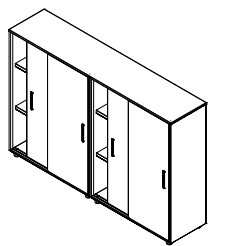
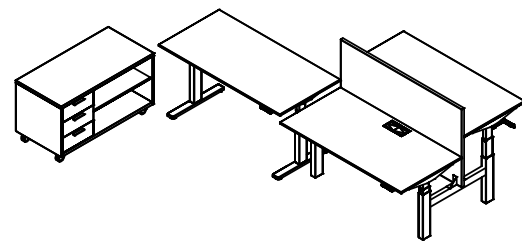
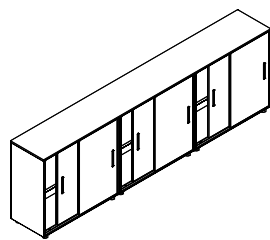

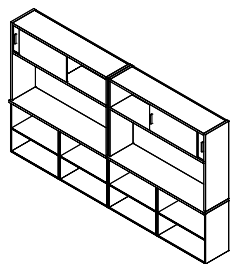
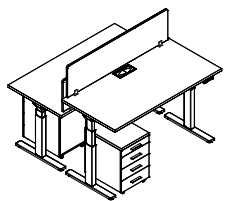

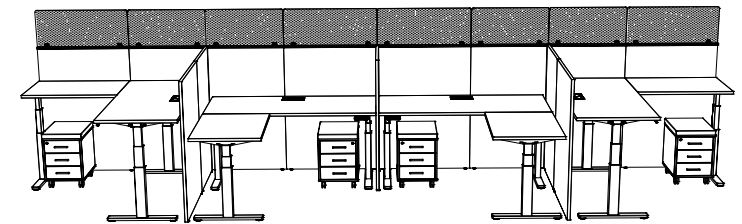

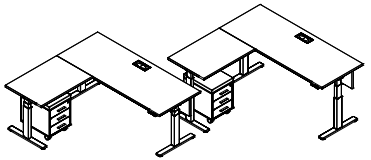
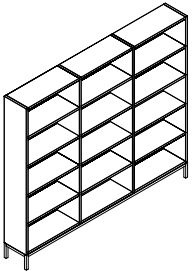

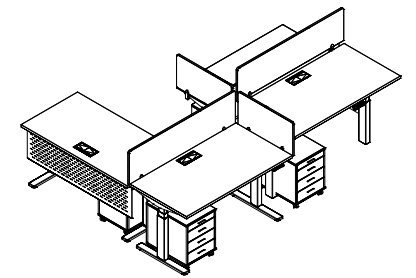
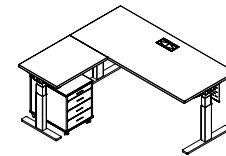
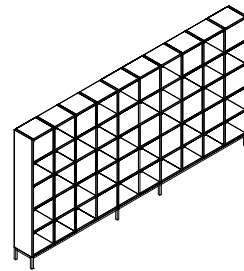

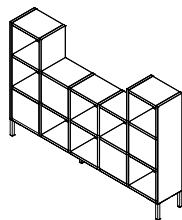
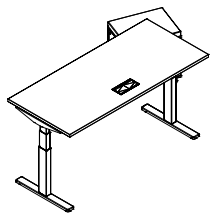
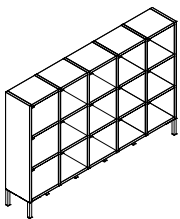
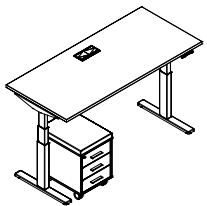

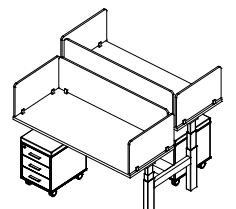
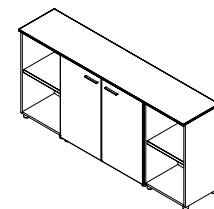
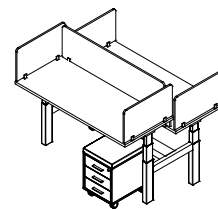

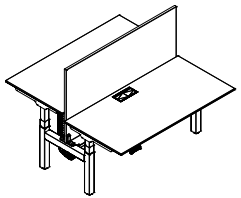
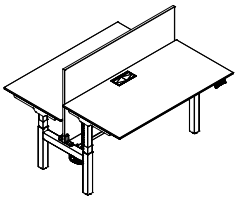

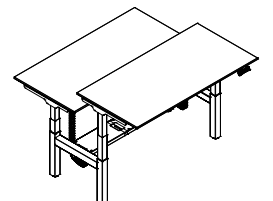
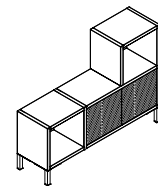

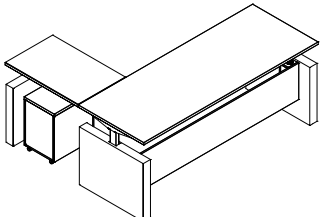
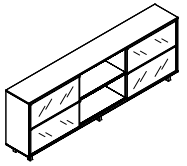

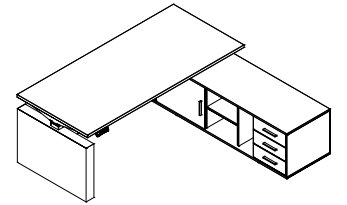
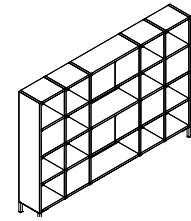

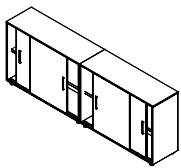
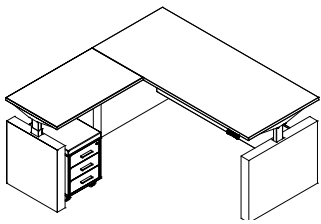

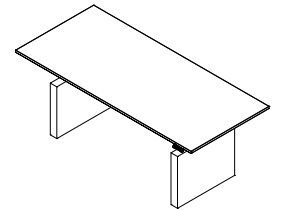
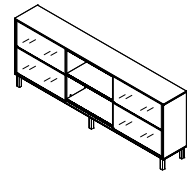

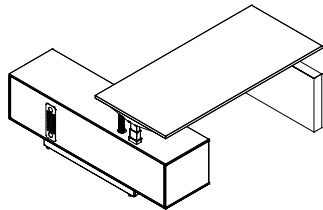
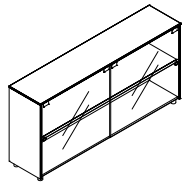

LEGS

Two (2) legs made of stamped sheet metal, coated in epoxy powder. Column is height adjustable via electrical motor as per the following characteristics:

- Height Adjustability Function: 3-Stage
- Electrical Motor: Single
- Column Cross-Section: Rectangular
- Height Range: 720 -1260mm
- Control panel with Up/Down and three memory buttons
- Height Adjustment Speed: 38mm/s
- Load Capacity: 125kg
- Power: 100-240V
- Sound Level: <50dB

Foot is fitted with leveling feet for possible floor level abnormalities. The front modesty panel brackets support can be fitted under the desk-top for simultaneous movement. Available in two versions to be used for tops of 80cm and 60cm in depth.

Supplied knock-down, packed in triple-layer cardboard and complete with screws for fixing to the tops.

HORIZONTAL SUPPORT BEAM

Single beam made of telescopic, U-shaped metal sheet. This feature allows using only one element to mount any top between 120 and 200cm in length. The internal compartment of the beam is used for the housing of the height adjustability accessories.

SIDE RETURN

It is a fixed cabinet-type wooden unit which includes 3 soft-closing drawers, lockable pedestal and a cabinet equipped with a sliding-door and a hinged door, operated with push-button. It carries a double backrest for the concealed housing of the foot leg as well as the cable chain compartment. Both, the telescopic-action leg, and the retractable cable chain, drive through special openings on the top of the side return.

The second leg is housed in a specialized closed unit in the same melamine material as the remaining structure.

DESKTOPS

These are available in rectangular shapes with edged tops. They are made of 30mm-thick melamine faced chipboard and edged with 1,3-2mm-thick matching PVC.

MODESTY PANELS FOR DESKS

Available in wood or in metal. The wooden one is made of 18 mm thick melamine-faced chipboard in matching colour with the desk top with PVC edging.

The metal one is available in perforated or solid form. Both types of the modesty panels are fitted under the desk top through special brackets.

KD FITTINGS

All connections are carried through a 4-part metal KD fitting. Metal inserts are permanently inserted in the core of the particleboard enabling easier and unlimited disassembly and re-assembly.

WOOD



3D DARK



3D GREY OAK



3D METALLIC



3D SNOW
White



3D WALNUT
NAPA



BEECH NWT



BEECH



BLACK



CHERRY S



CHERRY T



DARK HD



ELIA 3D

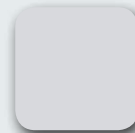

GREY SAND



MAHOGANY



ARTIC OAK



RIGE ICE



RIGE STONE



RIGE SUGAR



SILVER



WALNUT
AMATHUS



WALNUT
NICOSIE



WALNUT



WENGE



WHITE OAK



WHITE



OAK KERYNIA



3D SAWN WOOD
KAMBOS



3D PETRA
ROMIOU

FLY DIMENSIONS

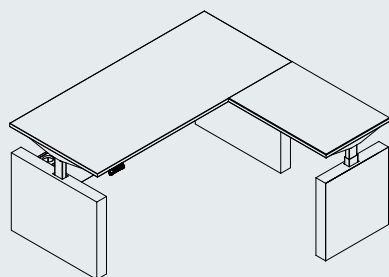

180x180	180x190	180x200
190x180	190x190	190x200
200x180	200x190	200x200

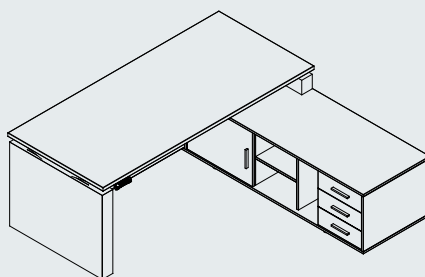

180x180	180x190	180x200
190x180	190x190	190x200
200x180	200x190	200x200

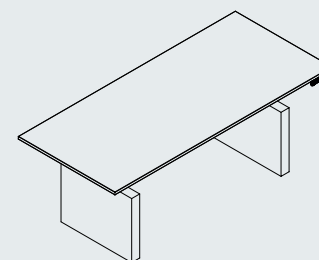

250x120
270x120

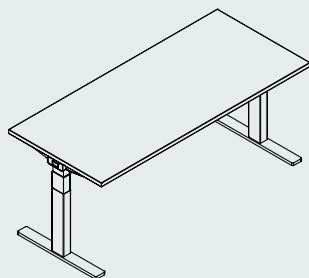

120x80	200x80x76
140x80	180x90x76
160x80	200x90x76
180x80	

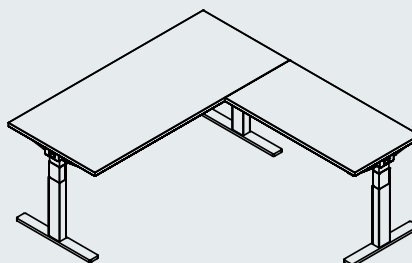

140x140	140x160	140x170
160x140	160x160	160x170
180x140	180x160	180x170

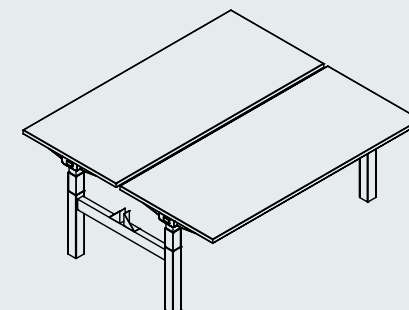

120x163	180x163	160x123
140x163	120x123	180x123
160x163	140x123	

Takis Charalambous & Co Ltd.

Head Office & Main Showroom:

19 Vyzantiou Str., 2064 Nicosia-Cyprus,
Tel: +357 22874444, Fax: +357 22495460,
Email: sales@takis.com

Factory & Stores:

Ergates Industrial Area, 2643 Nicosia-Cyprus,
Tel: +357 22621419, Fax: +357 22623007,
Email: operations@takis.com

Mailing / Web:

P.O.Box 28739, 2082 Nicosia-Cyprus,
<http://www.takis.com>

